

# ***CRAFTBOX COMFORT***



# ***SYMBOLS***



***ATTENTION***



***ASSEMBLY & ADJUSTMENT***



***OPERATION***



***STORAGE***

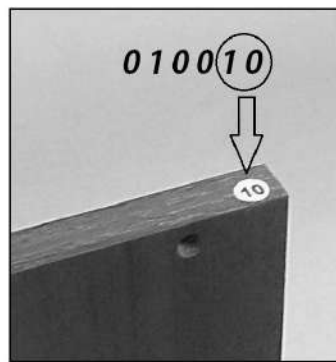

***INDICATING MARK***



***EQUALITY***

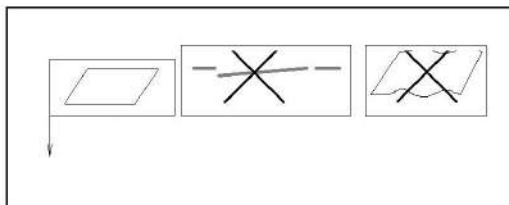

***EVEN SURFACE***

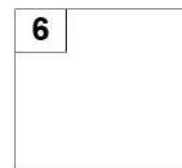

***STEP No***

**Module A**



**Module D**

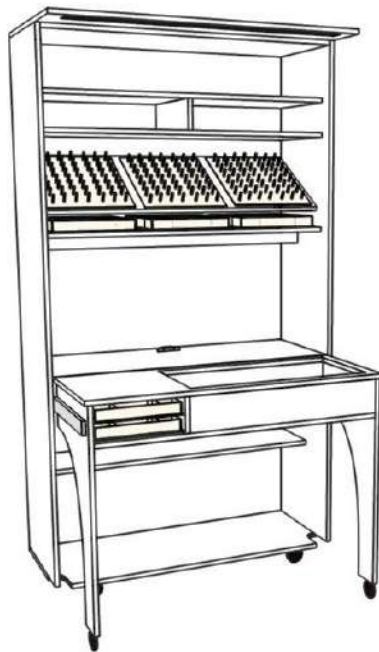

**Module B**



**Module E**



**Module C**



# Mod D



010001	1x	010003	1x	010004	1x	010006	1x
010009	1x	010018	1x	010025	1x	010026	1x
010027	1x	010029	1x	010031	1x	010033	2x
010034	1x						

020040 2x	020041 2x	020020 2x	020030 1x	020047 2x	4x 020049	1x 020012
--------------	--------------	--------------	--------------	--------------	-----------	-----------

030002 3,5 * 16 24x	030003 6,2 * 50 41x	030005 4,2 * 16 4x	030006 2,9 * 13 2x	030008 φ 4 2x	030009 M4 * 20 2x	030011 φ 15 41x	030012 φ 18 5x
---------------------------	---------------------------	--------------------------	--------------------------	---------------------	-------------------------	-----------------------	----------------------



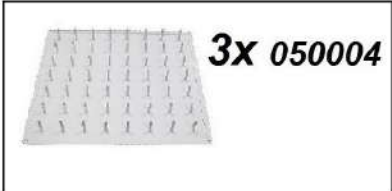
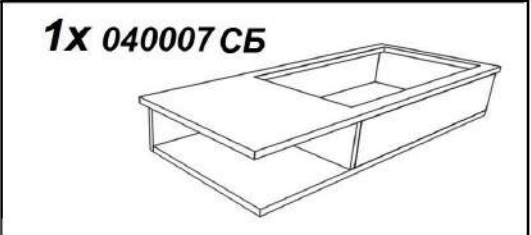
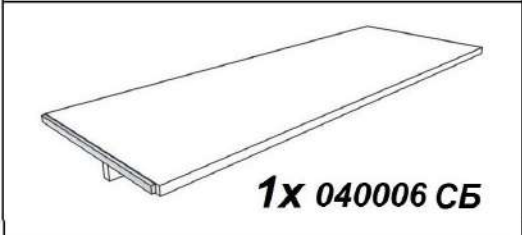
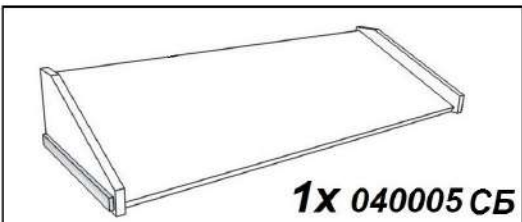





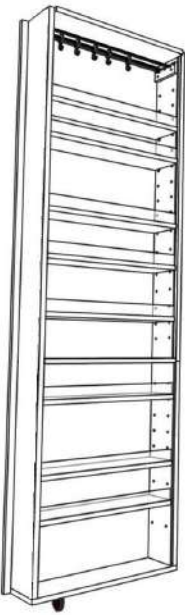

030013 L 35 5x	030014 φ 15 h 12 5x	030015 φ 8 * 30 4x	030022 M 10 4x	030023 φ 10 S1,8 4x	030031 φ 10 S2,5 4x
----------------------	---------------------------	--------------------------	----------------------	---------------------------	---------------------------



**Mod A**

040008 ASS









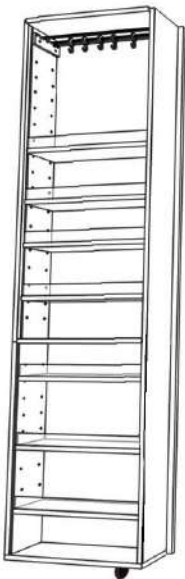



<b>2x 020010</b>  L 660		<b>1x 020038</b> 	<b>020016</b> <b>1x</b> 	<b>020040</b> <b>1x</b> 	
<b>030002</b>  3,5 * 16 <b>2x</b>	<b>030008</b>  φ 4 <b>2x</b>	<b>030009</b>  M4 * 20 <b>2x</b>	<b>030022</b>  M 10 <b>1x</b>		
<b>030023</b>  φ 10 S1,8 <b>1x</b>	<b>030031</b>  φ 10 S2,5 <b>1x</b>	<b>030038</b>  2,5 * 20 <b>44x</b>			

**Mod B**

040009 ASS









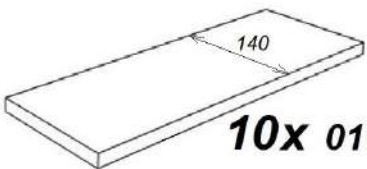
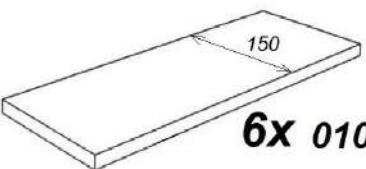

<b>2x 020010</b>  L 660		<b>1x 020038</b> 	<b>020040</b> <b>1x</b> 	<b>1x 020011</b> 		
<b>030001</b>  3 * 16 <b>2x</b>	<b>030008</b>  φ 4 <b>2x</b>	<b>030009</b>  M4 * 20 <b>2x</b>	<b>030022</b>  M 10 <b>1x</b>	<b>030023</b>  φ 10 S1,8 <b>1x</b>	<b>030031</b>  φ 10 S2,5 <b>1x</b>	<b>030038</b>  2,5 * 20 <b>44x</b>

**Mod A**





+



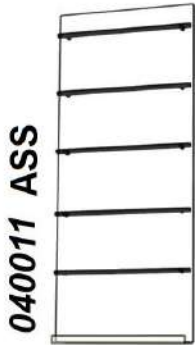

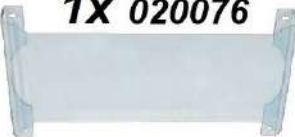

**Mod B**

 <b>10x 010034</b>		 <b>6x 010047</b>	
<b>80x 020020</b> 	<b>2x 020043</b>  φ 8 L = 455		<b>2x 020045</b>  φ 16 L = 455
<b>16x 020048</b> 	<b>020072</b> <b>10x</b> 	<b>8x 020077</b> 	<b>020078</b> <b>80x</b> 

**Mod E**





 11x 020072	2x 020073 	1x 020074 
5x 020075  L = 416		1x 020076 

030004  $\phi 5 * 16$ 4x	030005  4,2 * 16 4x	030039  M4 * 16 6x	030040  $\phi 4$ 6x	030041  M4 6x	030043  3,5 * 30 12x
--	---	--	--	---	--

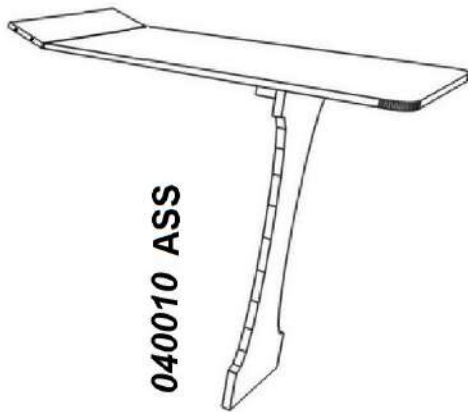
**Mod C**



030003  6,2 * 50 4x	030011  $\phi 15$ 4x
---	--



# Mod D



- 12x 030011 4
- 12x 030003

- 3x 030011 3
- 3x 030003

- 11 1x 020012
- 2x 030006

- 6 030011
- 13x 030003

- 7 020020
- 2x

- 9 030030
- 4x

- 8 4x 030029

- 1 2x 030022
- 2x
- 2x 030023
- 2x 020040

- 5 030011
- 7x 030003

- 2 2x 030022
- 2x
- 2x 030023
- 2x 020041

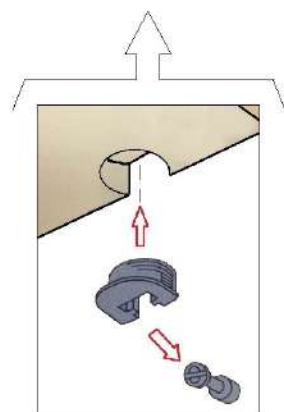
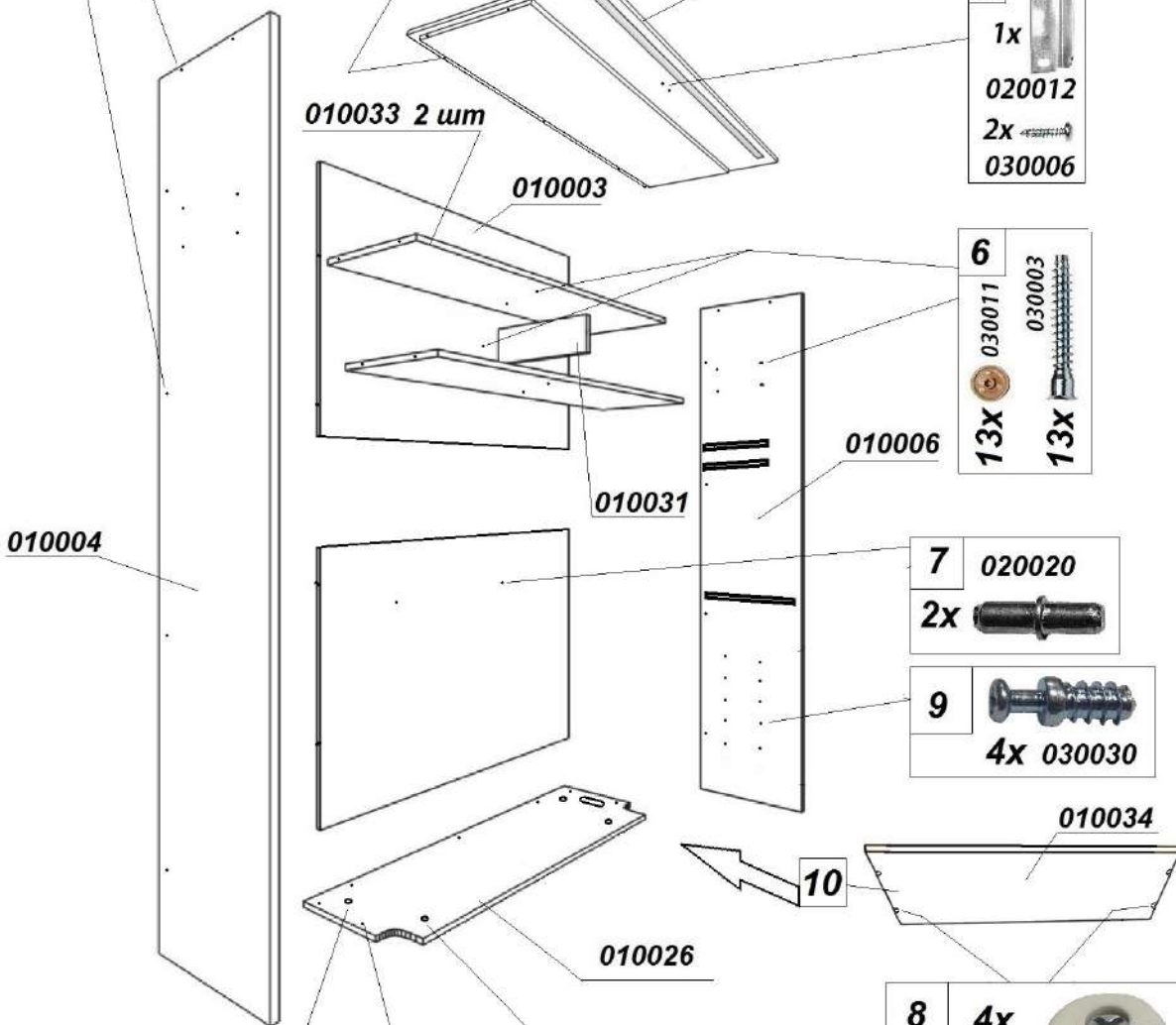



# Mod D



12 4x

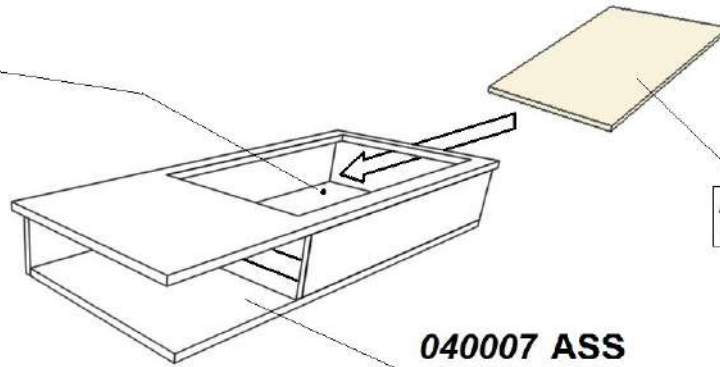

13 010009

040007 ASS



17 4x 030014  
4x 030012



18 1x 030014  
1x 030012



15 030013  
4x



030015 14  
4x

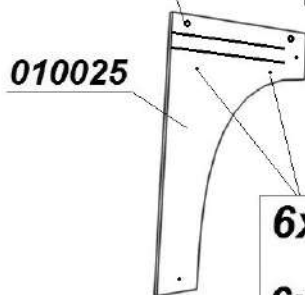

010025



6x 030011 20  
6x 030003



1x 030013 19



010027

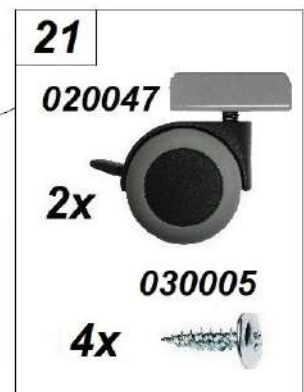

21 020047  
2x 030005  
4x

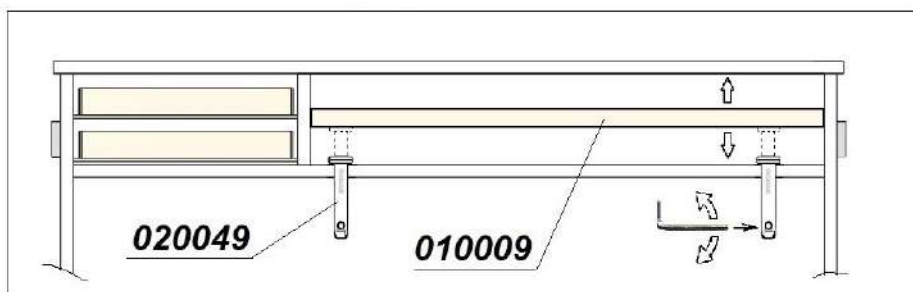

020049

010009





# Mod A

**26**  
2X 030008 2X 030009  
1X 020038

**24**  
22X 030038 2X 020010

**23**  
1X 020016  
2X 030002

**25**  
1X 030022  
1x  
1X 030023  
1X 020040

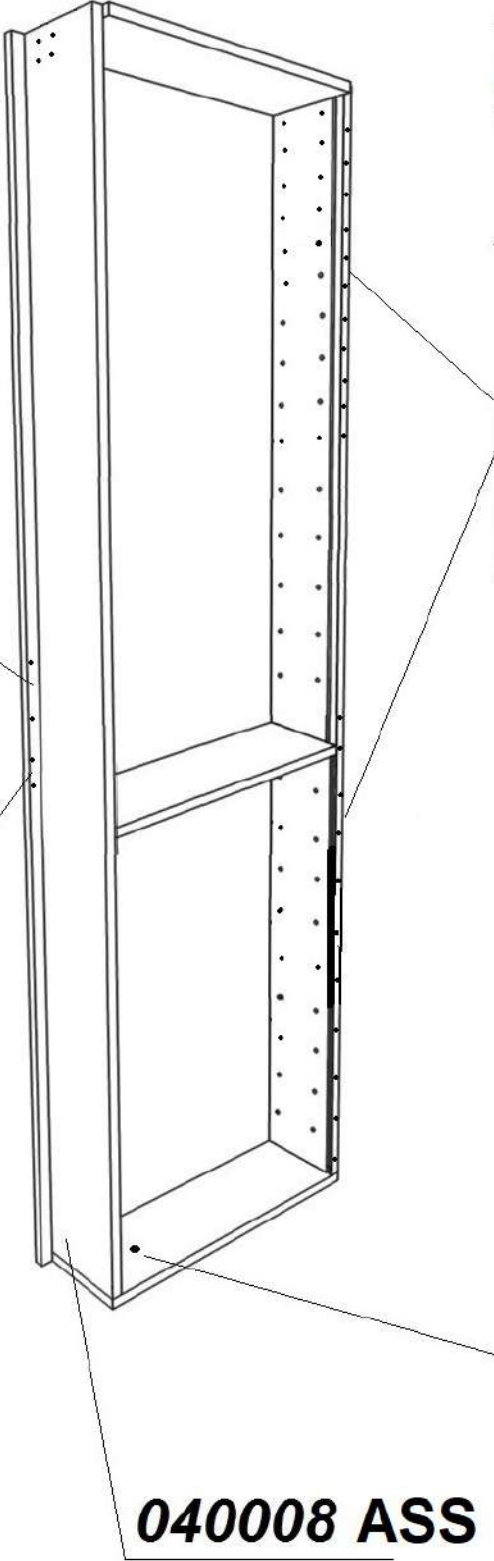



# Mod B

040009 ASS

**27**  
22X 030038 2X 020010

**29**  
030008 030009  
2X 2X  
1X 020038

**28**  
1X 030022  
1X  
1X 030023  
1X 020021

**30** 020011  
1X  
2X 030001



**Mod D**

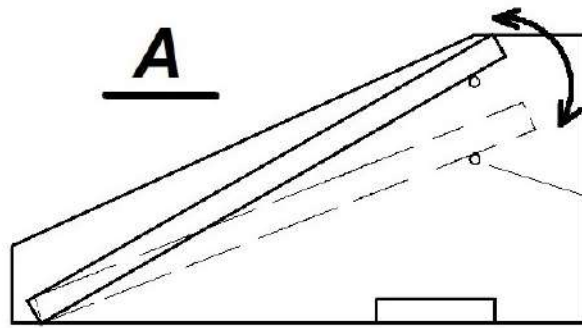

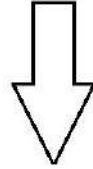

**020020**  
  
**2x**

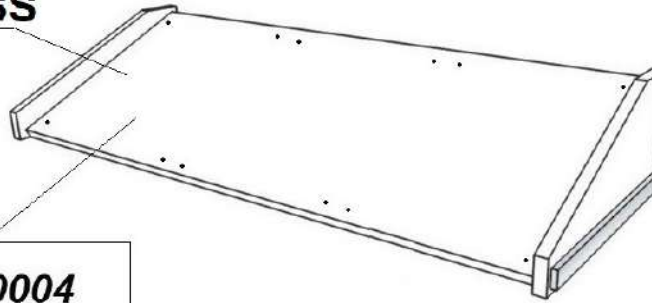

**040005 ASS**





**31** **3x 050004**  
  
**12x 030002** 

**32** **3x 050005**  
  
**12x 030002** 

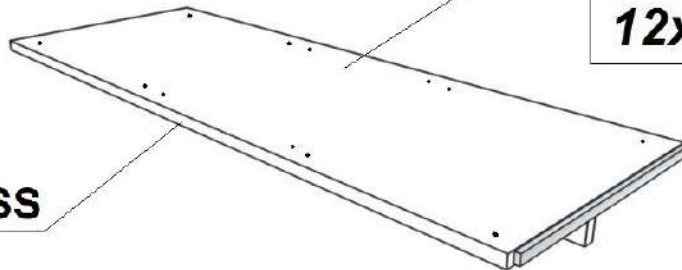
**040006 ASS**



**33** **1x 020030**  
  
**030008** **030009**  
**2x**  **2x** 

**010029**

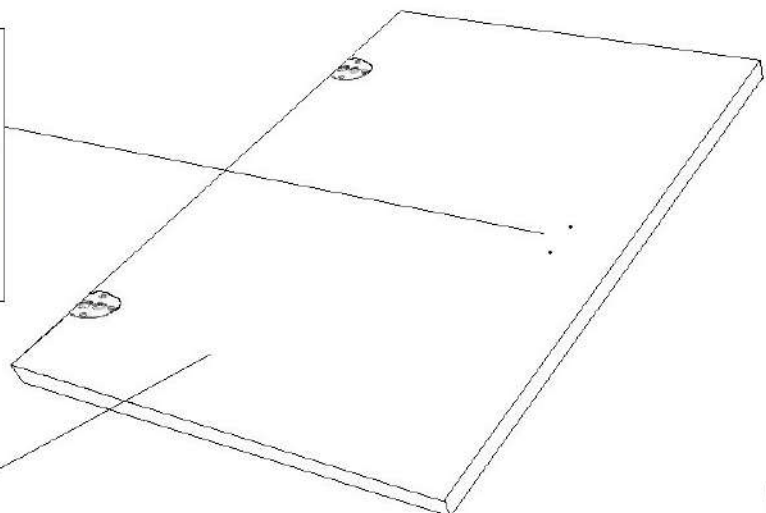

# Mod D

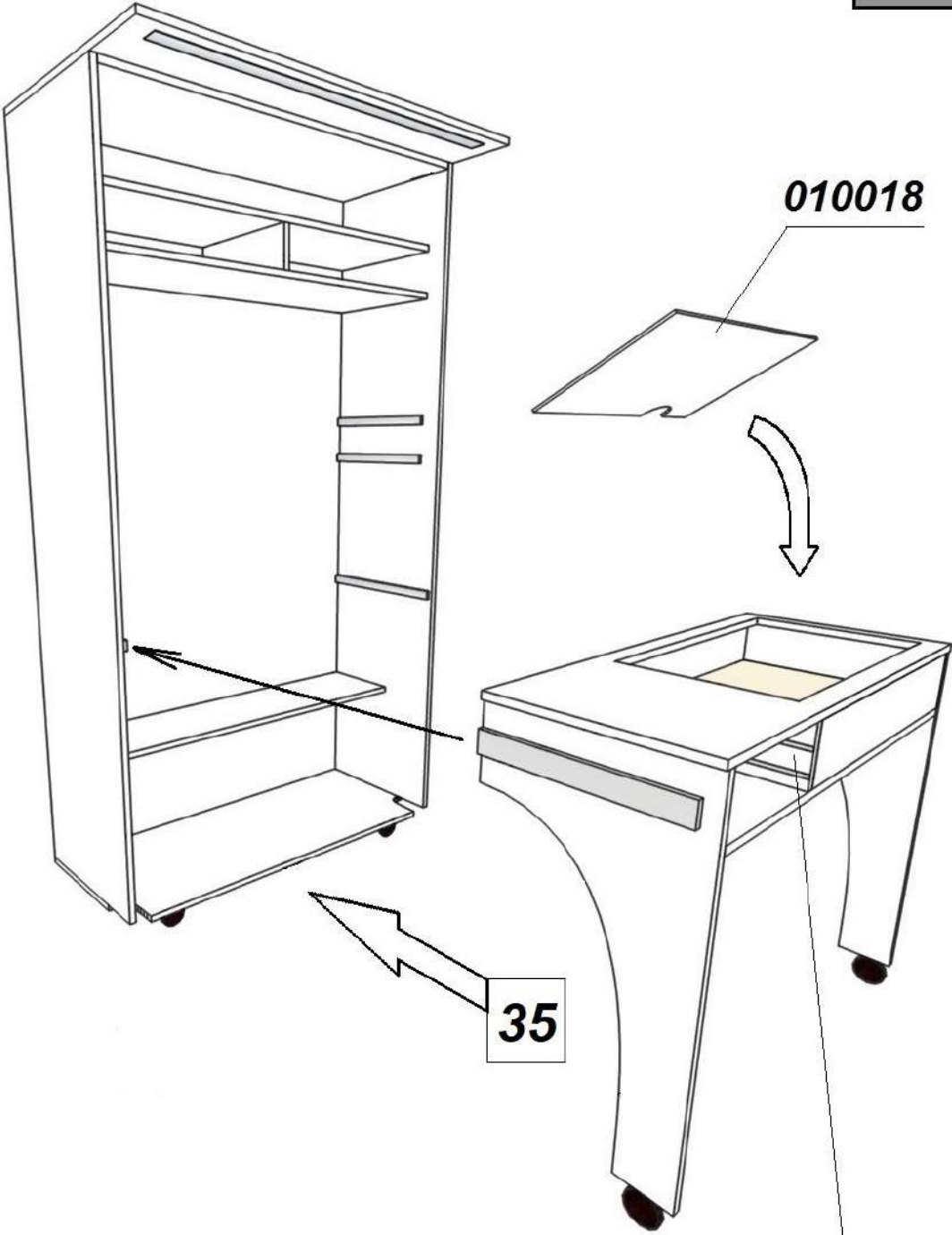



**Mod D**



**38**

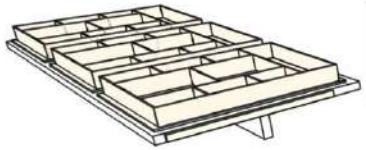

**37**

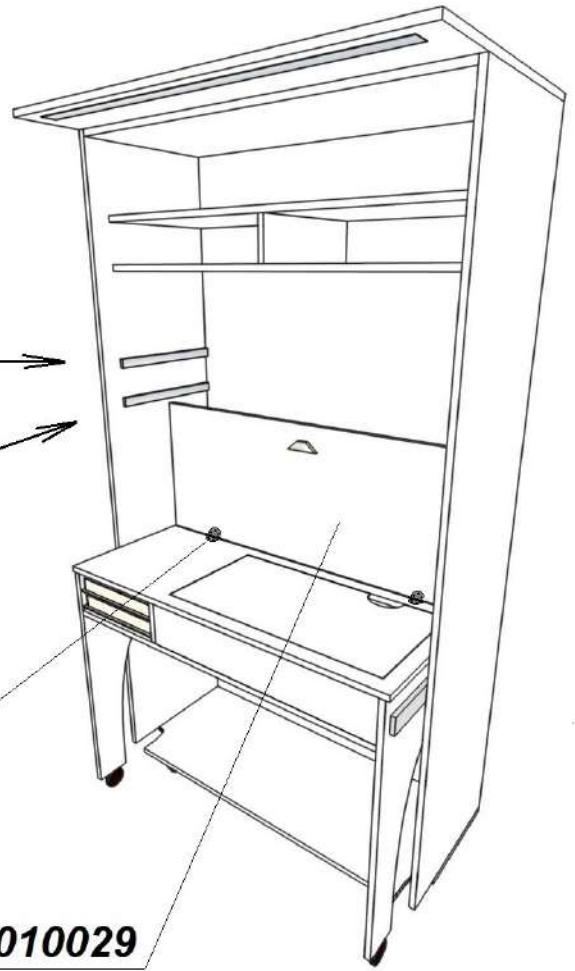

**010029**

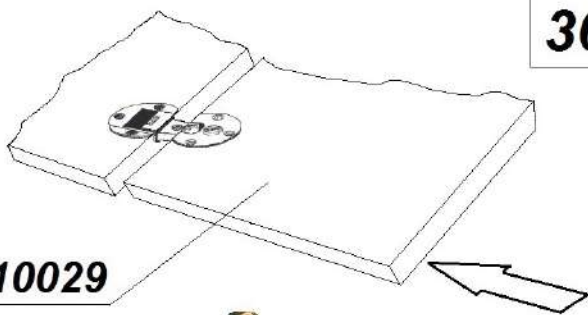

**36**

**010029**

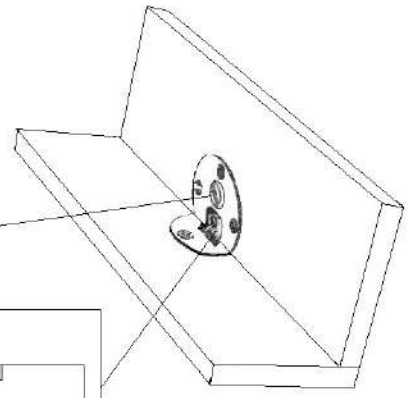
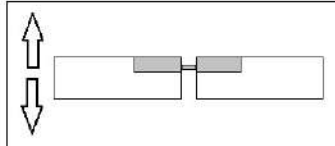
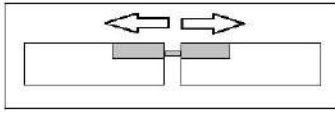
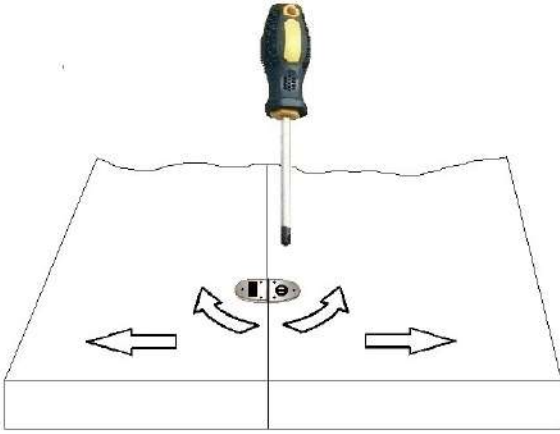

14



**Mod E**

**Mod A**

**Mod D**

**Mod B**

39 22x 030038

40 22x 030038

43  
11x 020072

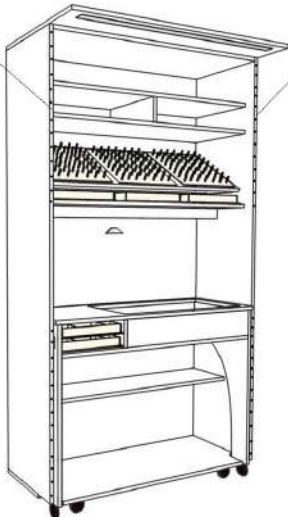
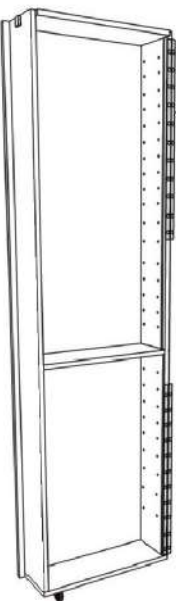

**Mod C**



42		4x		030039
2x		4x		030040
	020073	4x		030041

4x		030011	41
		030003	
4x			



**44** 030004  
**4x**

**48** 8x 020077

**50**   
**80x** 020020

**A**

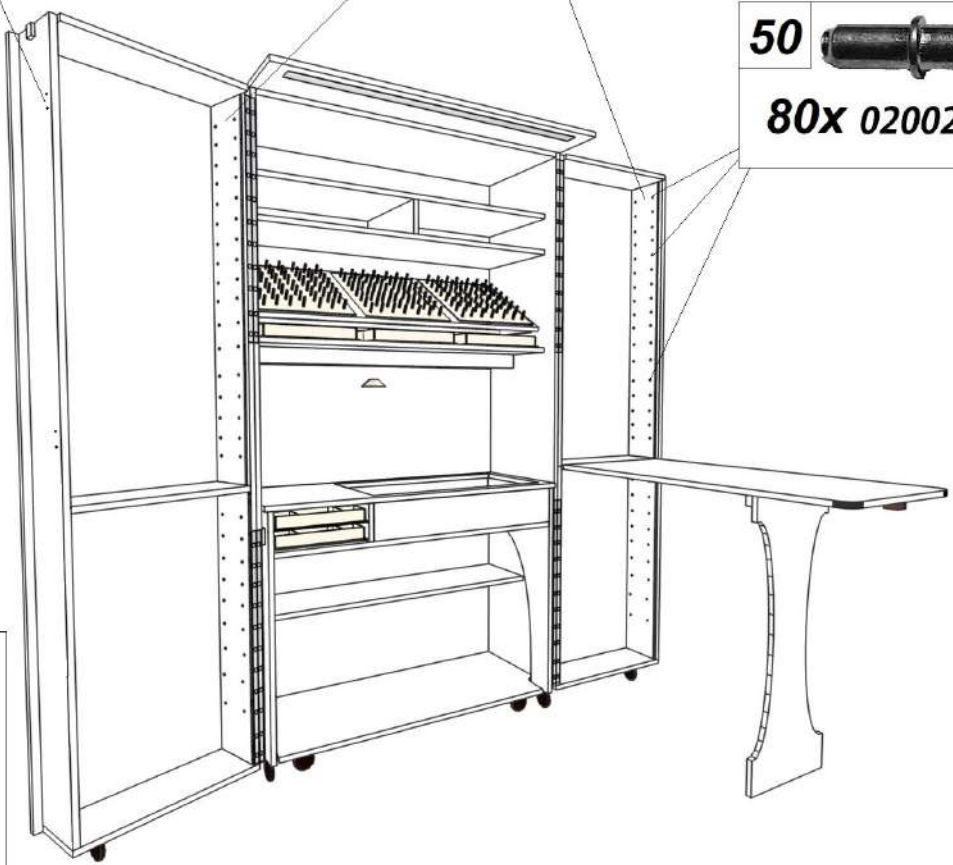
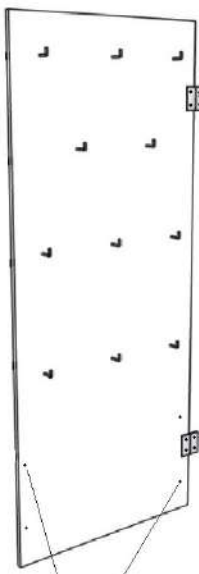

**45** 2x 030043  
  
1x 020076  
  
2x 030039  
2x 030040  
2x 030041

**A**

030004      030041



**46**   
**10x** 030043  
  
**5x** 020075

**47** 1x 020074  
  
**4x** 030005



**Mod B**

**Mod A**

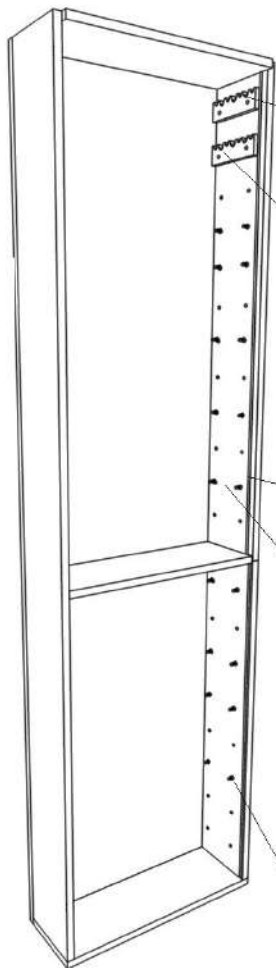

**51**      **2X 020043**

**52**      **2X 020045 10X 020072**

**54**      **16X 020048**

**53**      **10X 010034**

**55**      **80X 020078**

**53**      **6X 010047**

**Mod D**

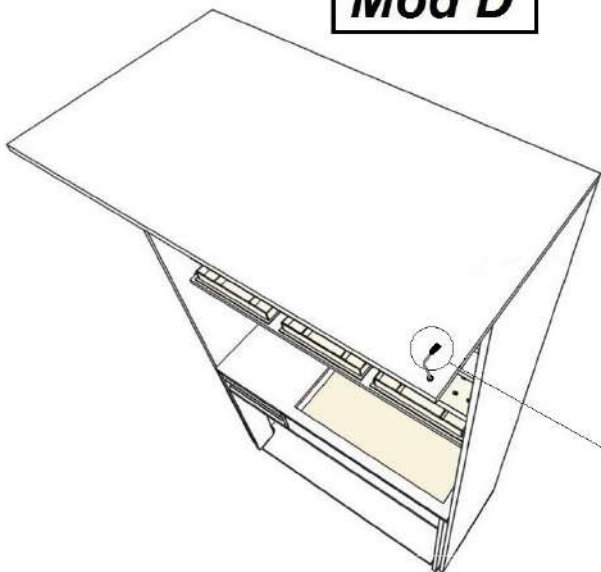

**56**      **1X 060001**





