

SEWING MACHINE TABLE
COMFORT 7 (C 7+)

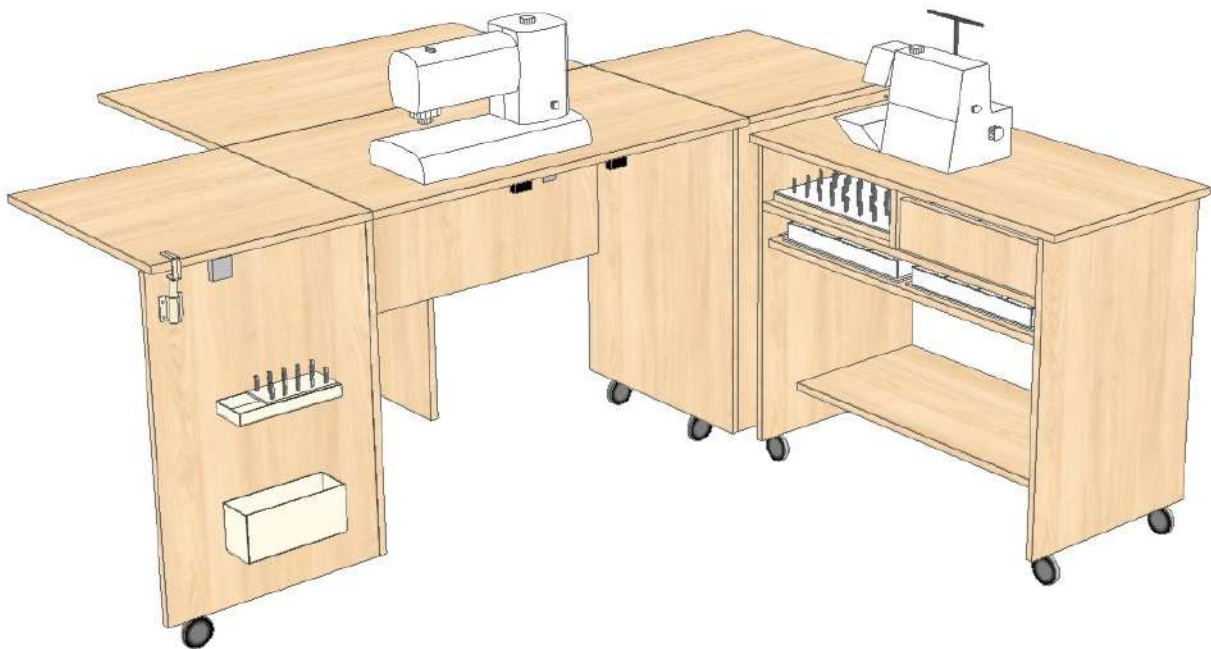

SYMBOLS



ATTENTION



ASSEMBLY & ADJUSTMENT



OPERATION

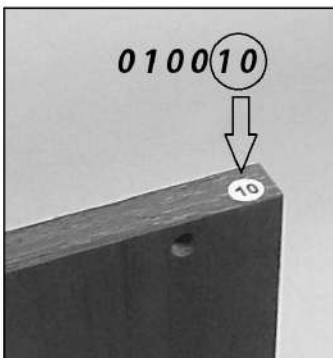



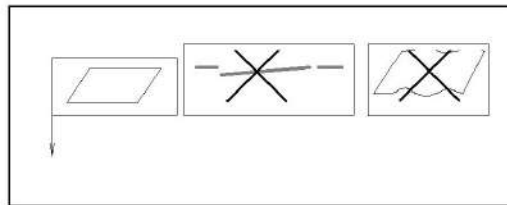



INDICATING MARK

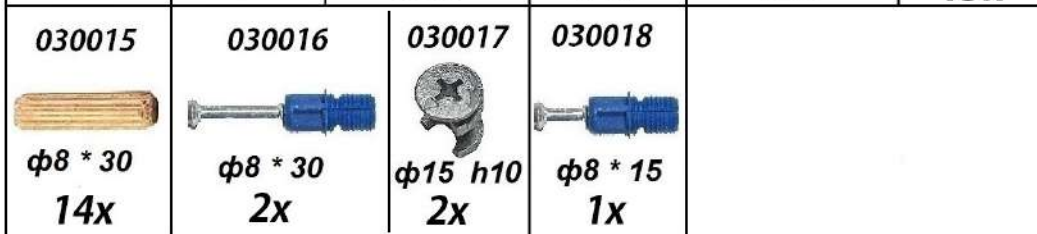
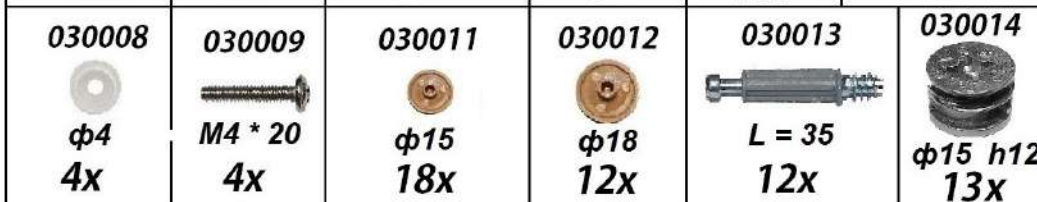
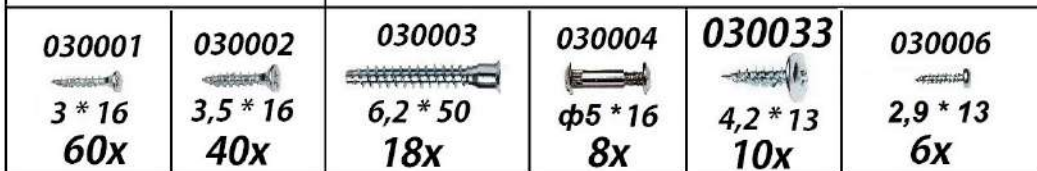
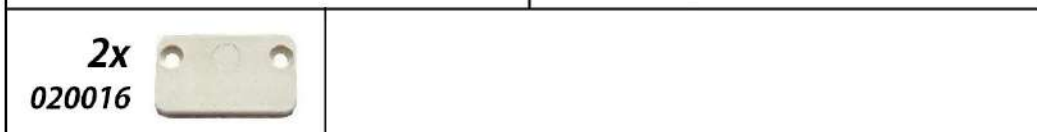
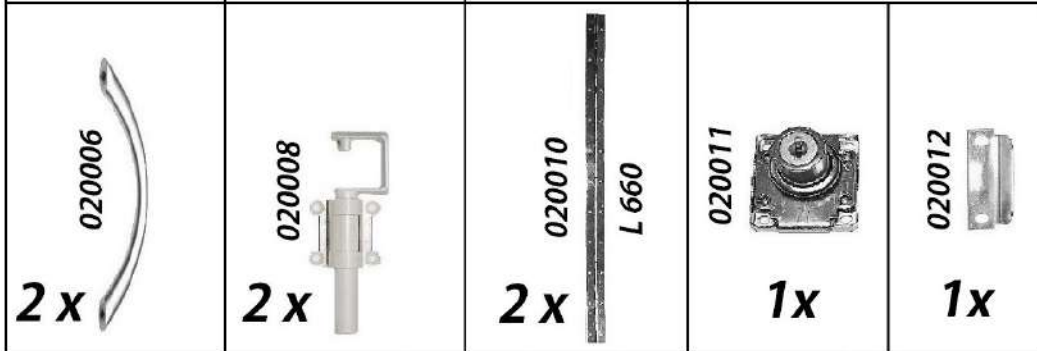
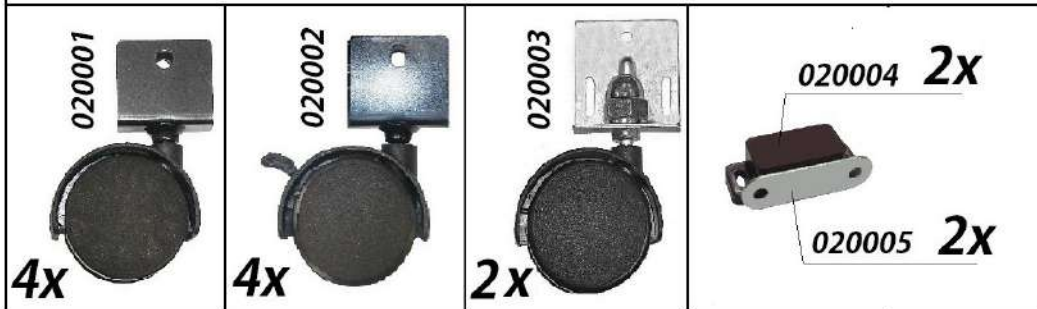

EVEN SURFACE

010001 1x	010002 1x	010003 1x	010004 1x
010006 1x	010007 1x	010008 1x	010010 1x
010011 1x	010012 1x	010013 1x	010015 1x
010023 1x	010024 1x	010025 1x	010026 1x
010027 1x	010028 1x	010030 1x	010031 1x
010032 1x			

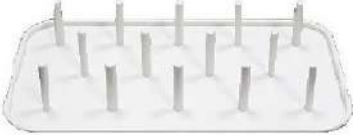





<p>1 x 050001</p> 	<p>1 x 050002</p> 
<p>1x 050004</p> 	<p>1 x 050003</p>  <p>2x 050005</p> 

<p>1x  S4</p>
--

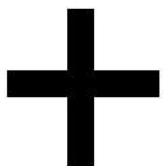

COMFORT 7+



<p>010018 1x</p> <p>010019 1x</p>	<p>020001</p> 	<p>5x 020019</p> 	<p>030004</p>  <p>$\phi 5 * 30$</p> <p>1x</p>	<p>030033</p>  <p>4,2 * 13</p> <p>20x</p>
---	--	--	---	---

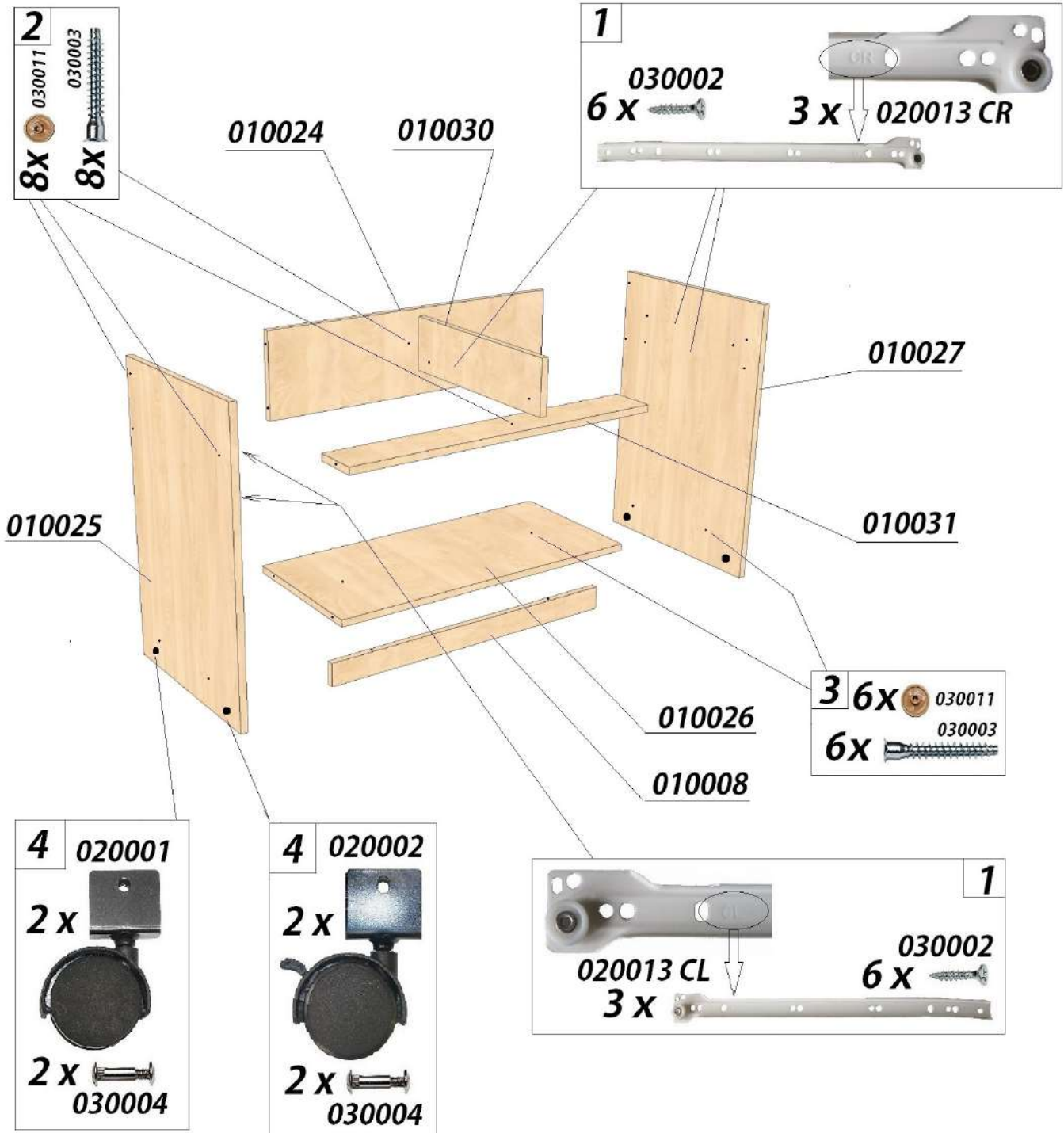

* Included into table set.

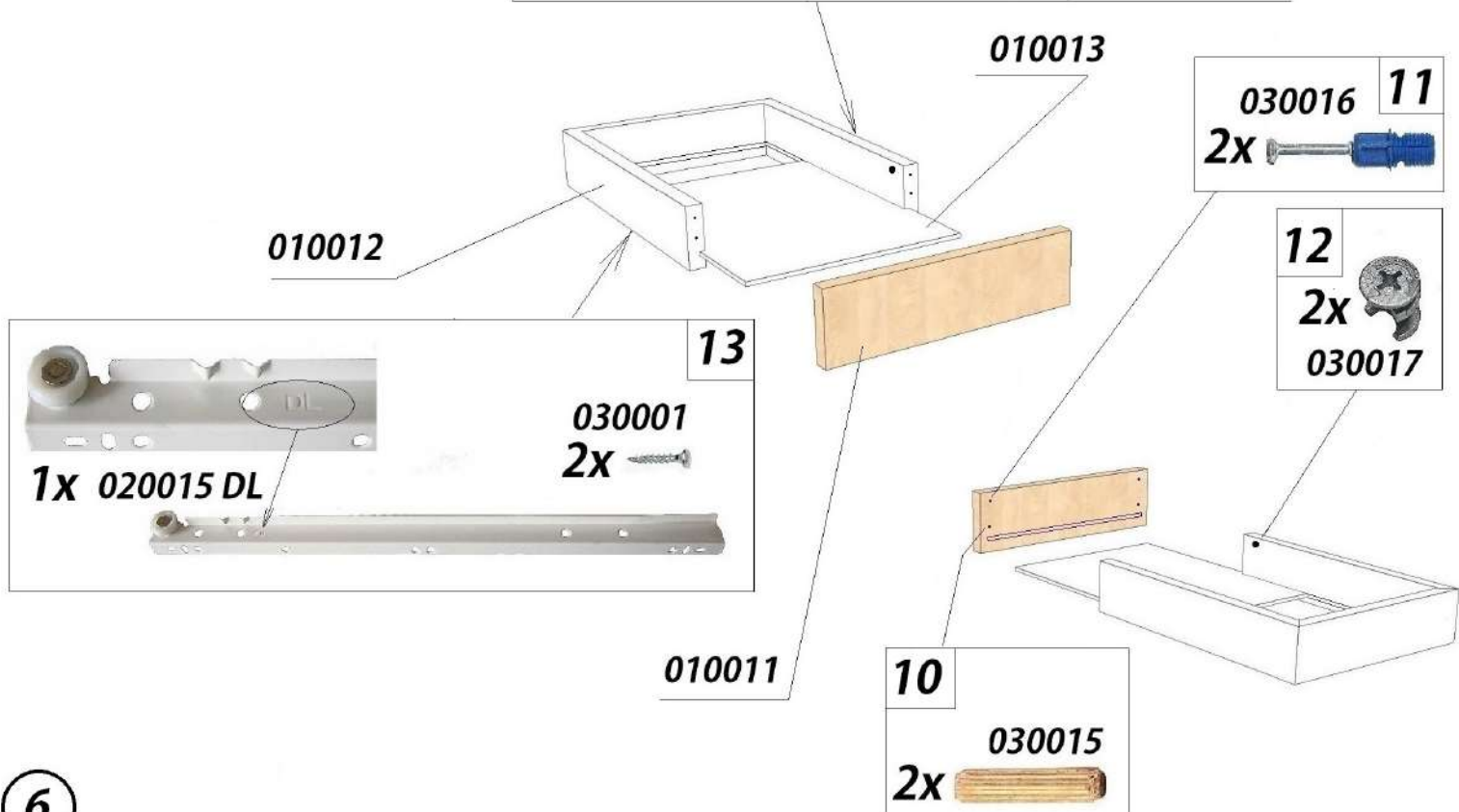
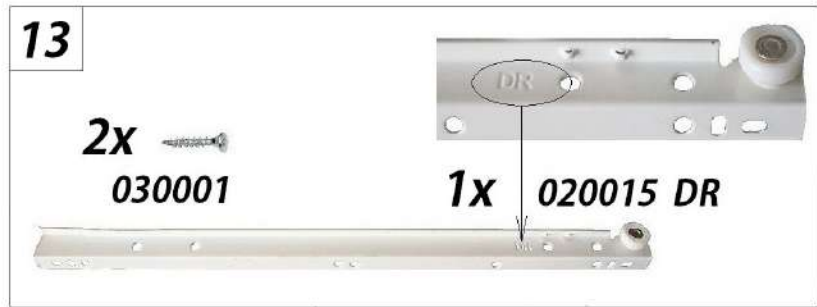
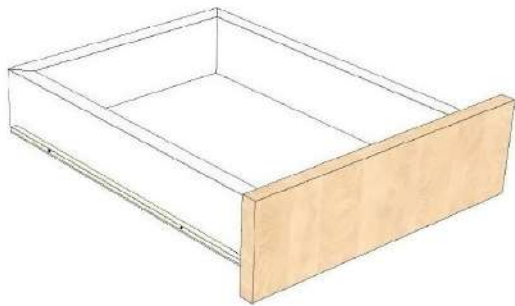
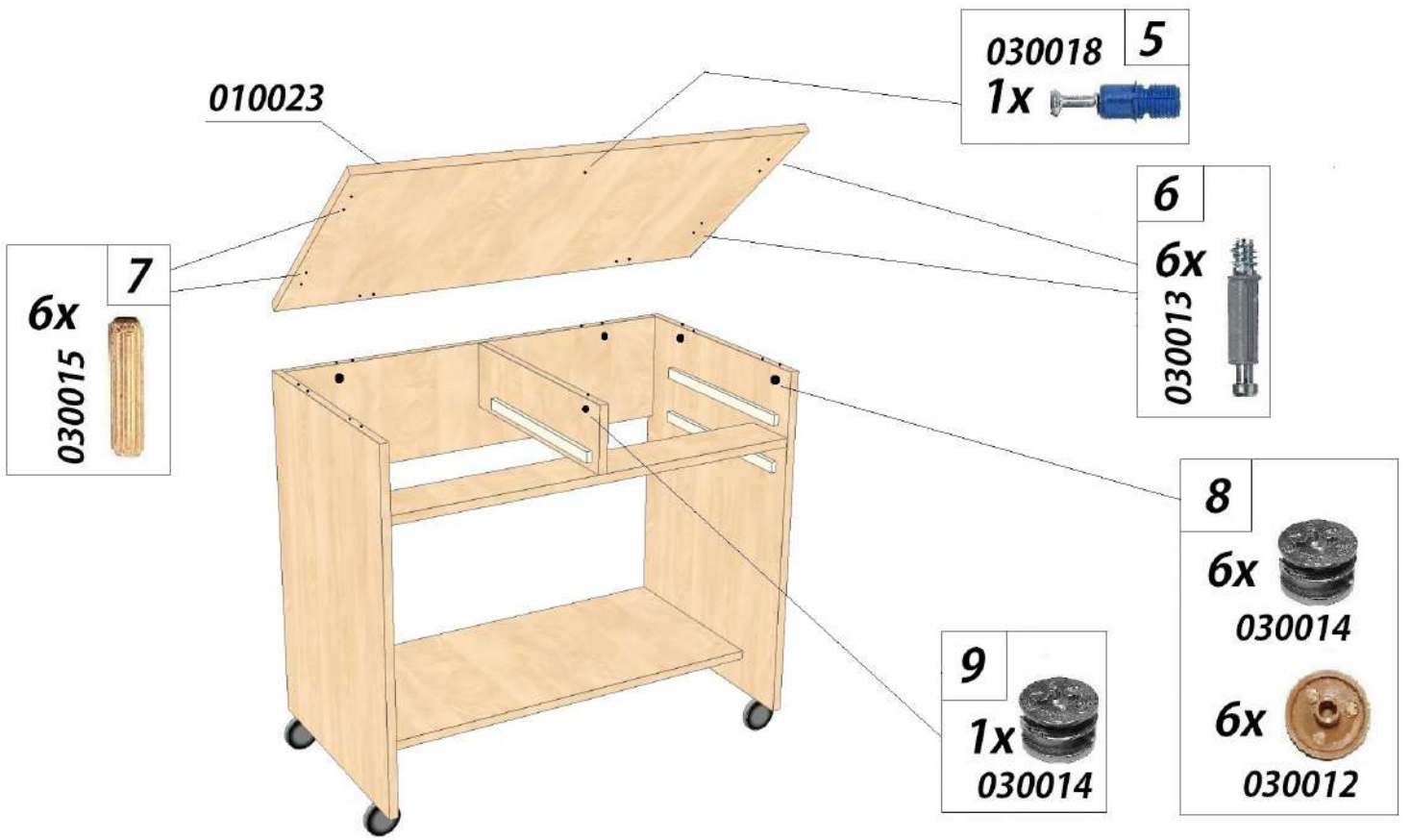

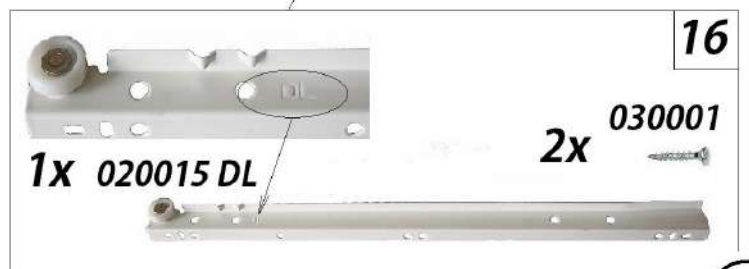
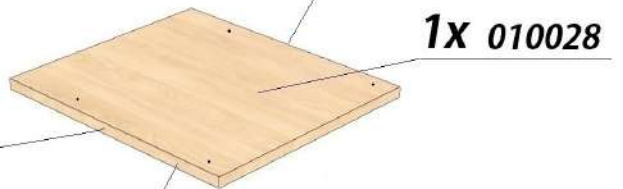
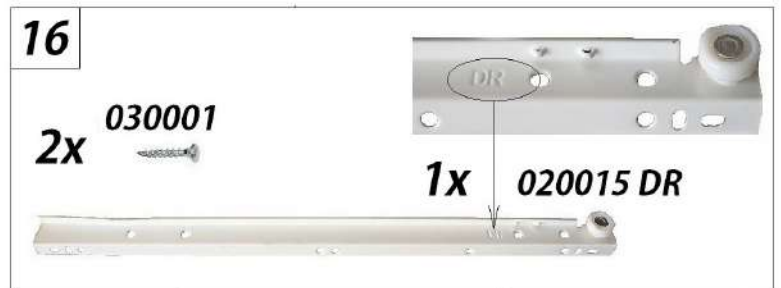
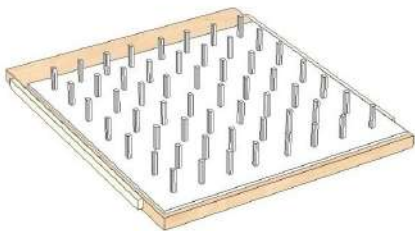
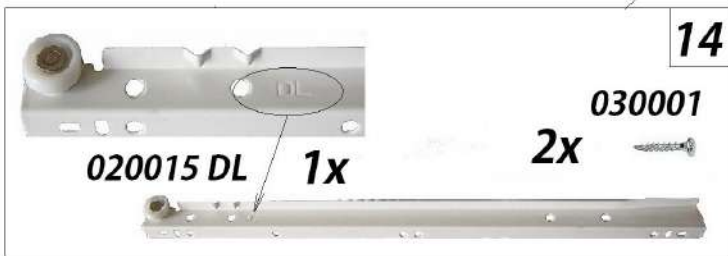
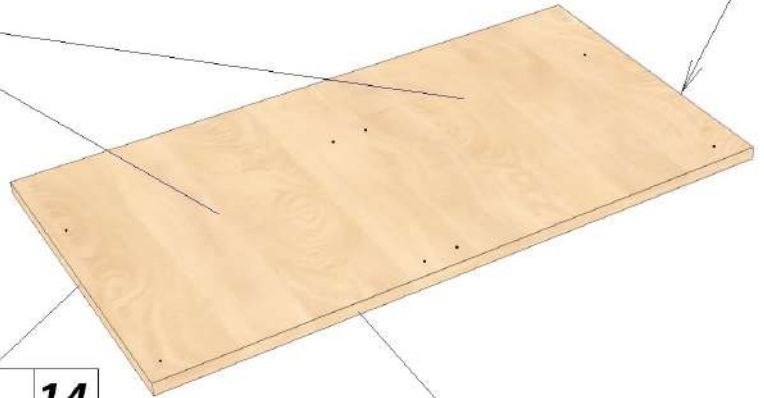
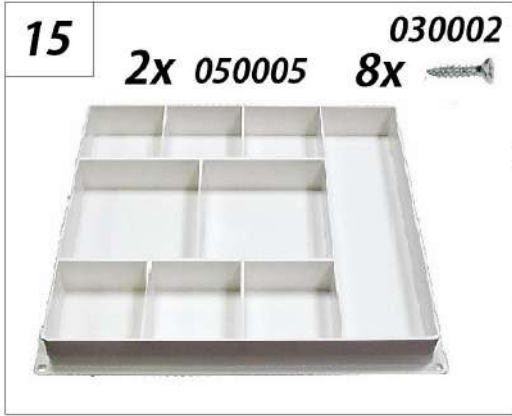
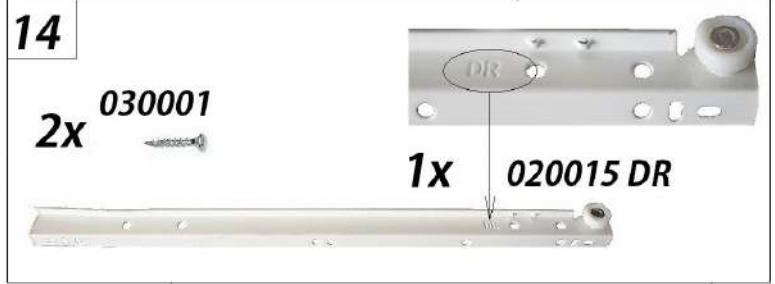
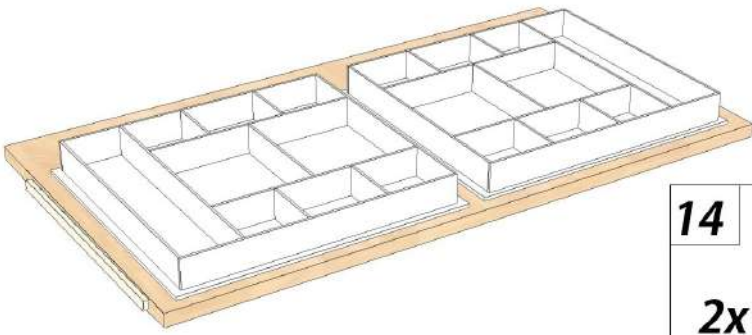

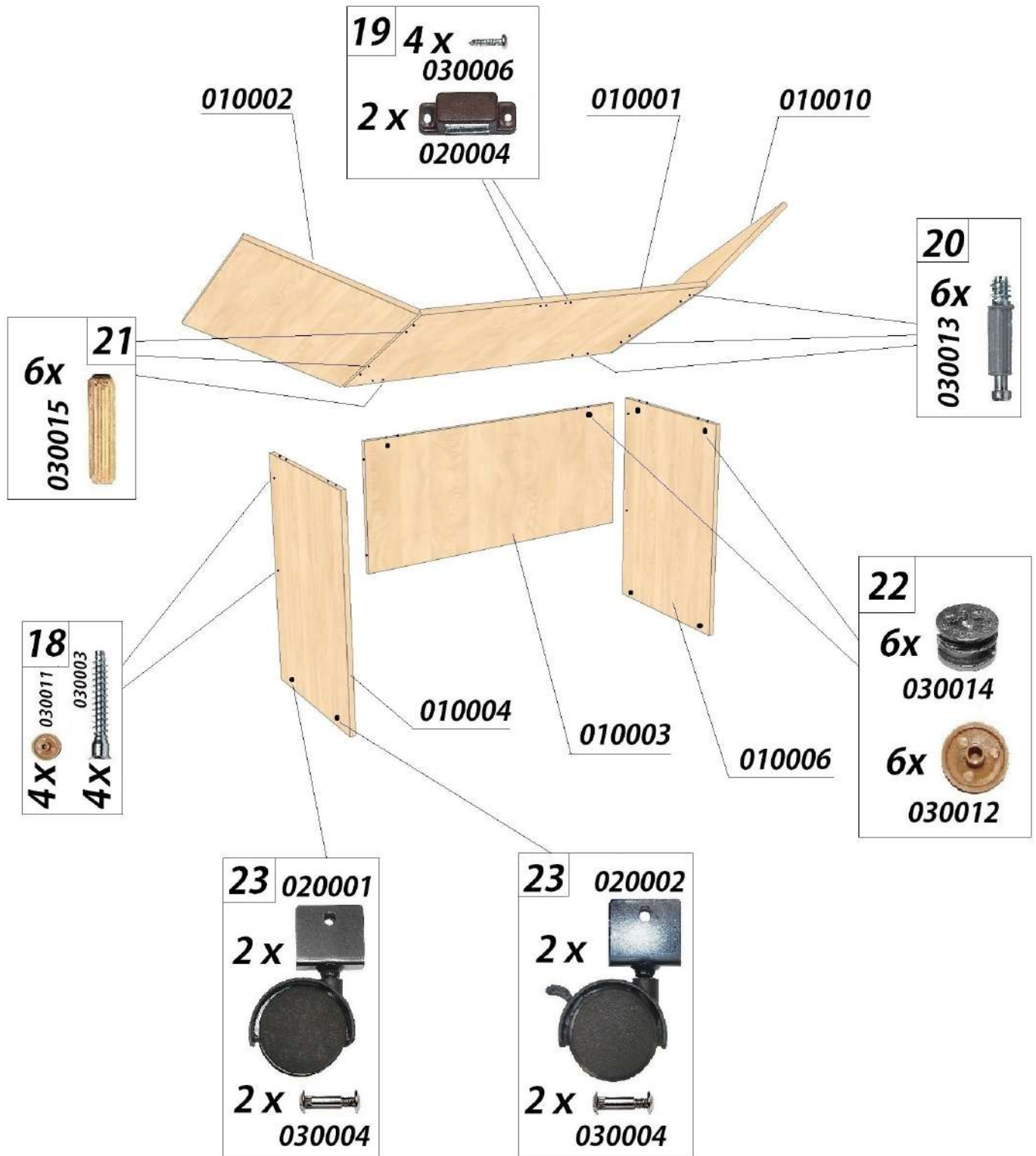

* Included into table set.

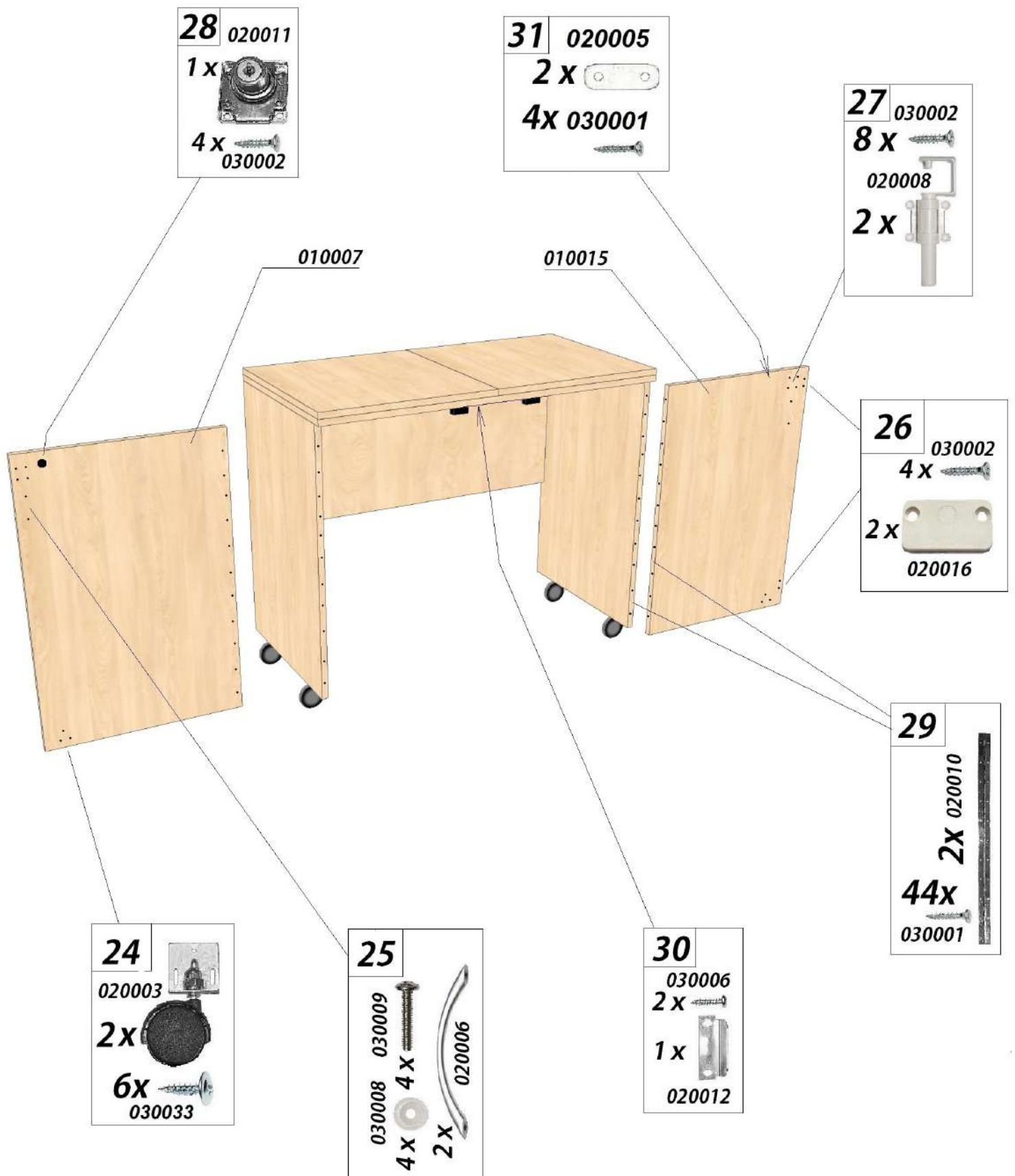



A

B

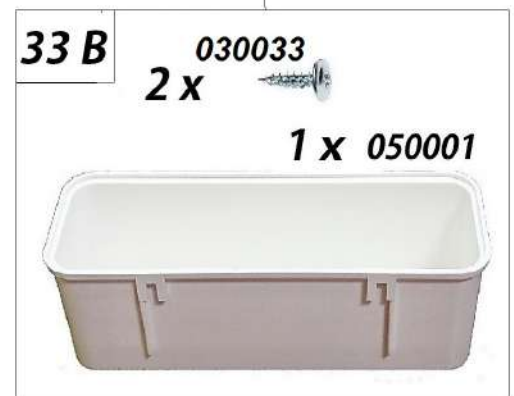
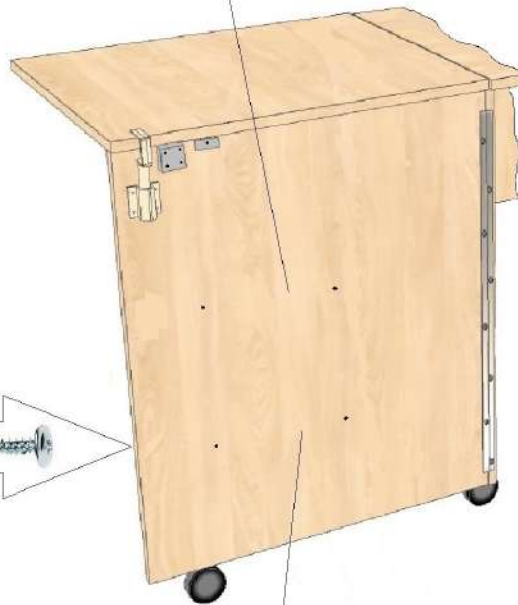
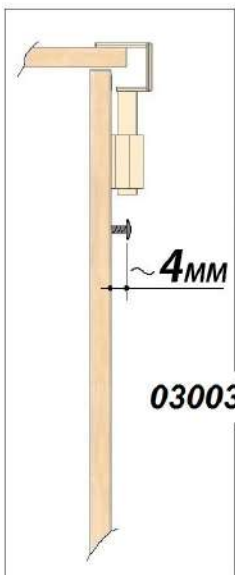



COMFORT 7+

36 12 x  030033



3 x 020019

35 8 x  030033

2 x 020019

